



TIMBERLINE ULTRAHD[®]

LIFETIME HIGH DEFINITION[®] SHINGLES

Color Shown:
Charcoal

TIMBERLINE[®] LIFETIME SHINGLES



*StainGuard Plus™ Time-Release Technology is available only on Timberline Ultra HD® Shingles sold in packages bearing the StainGuard Plus™ logo. Products with StainGuard Plus™ Time-Release Technology are covered by a 25-year limited warranty against blue-green algae discoloration. See *GAF Shingle & Accessory Ltd. Warranty* for complete coverage and restrictions.

Note: It is difficult to reproduce the color clarity and actual color blends of these products. Before selecting your color, please ask to see several full-size shingles.

TIMBERLINE® LIFETIME
SHINGLES — NORTH AMERICA'S
#1 — SELLING ROOF

Your Best Investment For An **Ultra-Dimensional** Shake Look

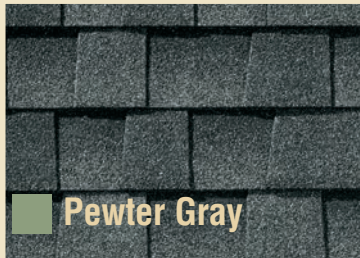
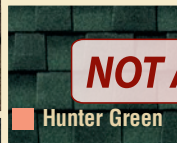

NOT APPROVED

NOT APPROVED

- **Best Investment...** Just pennies-a-day more than standard architectural shingles.¹
- **Ultra-Dimensional Look...** Up to 53% thicker than standard architectural shingles,¹ Timberline Ultra Dimensional Shingles feature GAF proprietary color blends and enhanced shadow effect for an ultra-dimensional wood-shake look on your roof.
- **Advanced Stain Resistance...** New patent-pending StainGuard Plus™ Time-Release Technology uses specially engineered capsules to release copper over time for long-lasting algae-fighting power.²
- **Highest Roofing Fire Rating...** UL Class A, Listed to ANSI/UL 790.
- **High Performance...** Designed with Advanced Protection® Shingle Technology, which reduces the use of natural resources while providing excellent protection for your home (visit gaf.com/aps to learn more).
- **Stays In Place...** Dura Grip™ Adhesive seals each shingle tightly and reduces the risk of shingle blow-off. Shingles are warranted to withstand winds up to 130 mph (209 km/h).³
- **Peace Of Mind...** Lifetime Ltd. transferable warranty with Smart Choice® Protection (non-prorated material and installation labor coverage) for the first ten years.⁴
- **Perfect Finishing Touch...** Use Timbercrest® Premium Ridge Cap Shingles or TimberCrest™ Premium SBS-Modified Ridge Cap Shingles (visit www.gaf.com/ridgecapavailability for availability in your area).

¹ Note: Comparison refers to Timberline HD® Shingles. Thickness varies by plant; see actual shingles for comparison.
² StainGuard Plus™ Time-Release Technology is available only on Timberline Ultra HD® Shingles sold in packages bearing the StainGuard Plus™ logo. Products with StainGuard Plus™ Time-Release Technology are covered by a 25-year limited warranty against blue-green algae discoloration. See *GAF Shingle & Accessory Ltd. Warranty* for complete coverage and restrictions.
³ This wind speed coverage requires special installation; see *GAF Shingle & Accessory Ltd. Warranty* for details.
⁴ See *GAF Shingle & Accessory Ltd. Warranty* for complete coverage and restrictions. The word "Lifetime" refers to the length of coverage provided by the *GAF Shingle & Accessory Ltd. Warranty* and means as long as the original individual owner(s) of a single-family detached residence (or the second owner(s) in certain circumstances) owns the property where the shingles are installed. For owners/structures not meeting the above criteria, Lifetime coverage is not applicable.

Most Popular Ultra HD® Shingle Colors Regional Ultra HD® Shingle Colors

See chart on page 14 for color availability.

Where They Fit Within The Lifetime Roofing System

1. Lifetime Shingles

2. Leak Barrier
3. Starter Strip Shingles
4. Roof Deck Protection
5. Cobra® Attic Ventilation
6. Ridge Cap Shingles

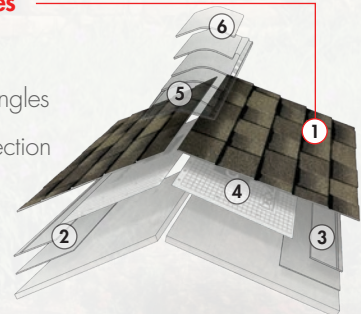



TIMBERLINE HD[®]

LIFETIME HIGH DEFINITION SHINGLES

TIMBERLINE[®] LIFETIME SHINGLES

Color Shown:
Pewter Gray



U.S. only

*StainGuard[®] algae protection is available only on shingles sold in packages bearing the StainGuard[®] logo. Products with StainGuard[®] algae protection are covered by a 10-year limited warranty against blue-green algae discoloration. See *GAF Shingle & Accessory Ltd. Warranty* for complete coverage and restrictions.

Note: It is difficult to reproduce the color clarity and actual color blends of these products. Before selecting your color, please ask to see several full-size shingles.



NOT APPROVED

Barkwood

Biscayne Blue

Birchwood

Canadian Driftwood

NOT APPROVED

Charcoal

Copper Canyon

Driftwood

Hickory

Fox Hollow Gray

NOT APPROVED

Hunter Green

Golden Amber⁴

Oyster Gray

Mission Brown

NOT APPROVED

Patriot Red

Pewter Gray

Sunset Brick

White^{5,6}
U.S. only

Shakewood

Williamsburg Slate

Slate

Weathered Wood

TIMBERLINE® LIFETIME SHINGLES — NORTH AMERICA'S #1 — SELLING ROOF

Value & Performance In A Genuine Wood-Shake Look

- **Great Value...** Architecturally stylish but practically priced — with a Lifetime Ltd. warranty.¹
- **Dimensional Look...** Features GAF proprietary color blends and enhanced shadow effect for a genuine wood-shake look.
- **Highest Roofing Fire Rating...** UL Class A, Listed to ANSI/UL 790.
- **StainGuard® Algae Protection...** Helps ensure the beauty of your roof against unsightly blue-green algae.²
- **High Performance...** Designed with Advanced Protection® Shingle Technology, which reduces the use of natural resources while providing excellent protection for your home (visit gaf.com/aps to learn more).
- **Stays In Place...** Dura Grip™ Adhesive seals each shingle tightly and reduces the risk of shingle blow-off. Shingles are warranted to withstand winds up to 130 mph (209 km/h).³
- **Peace Of Mind...** Lifetime Ltd. transferable warranty with Smart Choice® Protection (non-prorated material and installation labor coverage) for the first ten years.¹
- **Perfect Finishing Touch...** Use Timbertex® Premium Ridge Cap Shingles or TimberCrest™ Premium SBS-Modified Ridge Cap Shingles (visit www.gaf.com/ridgecap for availability in your area).

¹ GAF Shingle & Accessory Ltd. Warranty for complete coverage and restrictions. "The" refers to the length of coverage provided by the GAF Shingle & Accessory Ltd. Warranty and means as long as the original individual owner(s) of a single-family detached residence [or the second owner(s) in certain circumstances] owns the property where the shingles are installed. For owners/structures not meeting the above criteria, Lifetime coverage is not applicable.

² StainGuard® algae protection is available only on shingles sold in packages bearing the StainGuard® logo. Products with StainGuard® algae protection are covered by a 10-year limited warranty against blue-green algae discoloration. See GAF Shingle & Accessory Ltd. Warranty for complete coverage and restrictions.

³ This wind speed coverage requires special installation; see GAF Shingle & Accessory Ltd. Warranty for details.

⁴ Limited availability.

⁵ Rated by the Cool Roof Rating Council (CRRCC) and can be used to comply with 2016 Title 24, Part 6, Cool Roof Requirements of the California Code of Regulations.

⁶ Timberline HD® White is ENERGY STAR® certified (U.S. only). Energy cost savings are not guaranteed and the amount of savings may vary based on climate zone, utility rates, radiative properties of roofing products, insulation levels, HVAC equipment efficiency, and other factors.

Most Popular High Definition® Shingle Colors Regional High Definition® Shingle Colors

See chart on page 14 for color availability.

Where They Fit Within The Lifetime Roofing System

1. Lifetime Shingles
2. Leak Barrier
3. Starter Strip Shingles
4. Roof Deck Protection
5. Cobra® Attic Ventilation
6. Ridge Cap Shingles

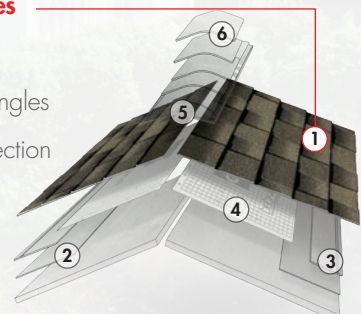



TIMBERLINE
LIFETIME HIGH DEFINITION SHINGLES

Color Availability

TIMBERLINE HD

LIFETIME HIGH DEFINITION SHINGLES

	1	2	3	4	5	6	7	8	9	10	11
Most Popular Colors:											
Barkwood	•	•	•	•	•	•	•	•	•	•	•
Birchwood	•	•	•	•	•	•	•	•	•	•	•
Charcoal	•	•	•	•	•	•	•	•	•	•	•
Hickory	•	•	•	•	•	•	•	•	•	•	•
Hunter Green	•	•	•	•	•	•	•	•	•	•	•
Mission Brown	•	•	•	•	•	•	•	•	•	•	•
Pewter Gray	•	•	•	•	• ¹	•	•	•	•	•	•
Shakewood	•	•	•	•	•	•	•	•	•	•	•
Slate	•	•	•	•	•	•	•	•	•	•	•
Weathered Wood	•	•	•	•	•	•	•	•	•	•	•
Regional Colors:											
Biscayne Blue	•										
Canadian Driftwood								•	•	•	•
Copper Canyon					•						
Driftwood					•		•				
Fox Hollow Gray	•	•									
Golden Amber ¹					•						
Oyster Gray	•						•				
Patriot Red	•										
Sunset Brick						•					
White ^{2,3}						•	•				
Williamsburg Slate	•	•									

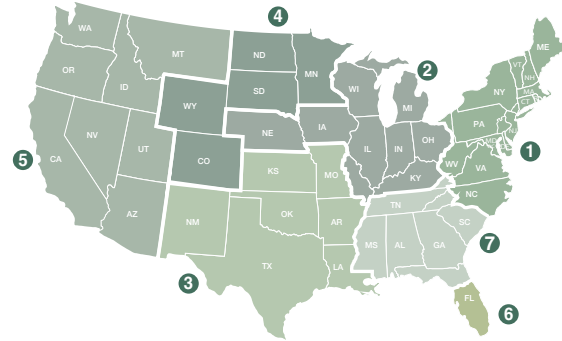
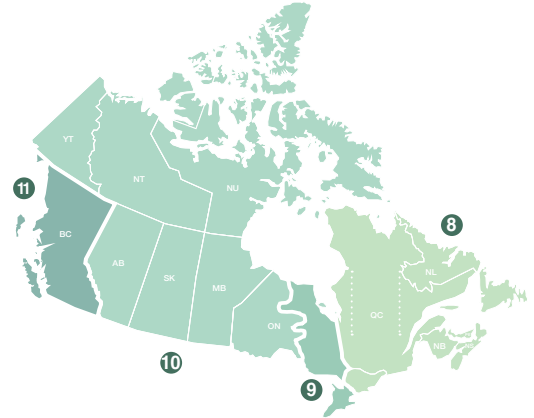

TIMBERLINE ULTRA HD

LIFETIME HIGH DEFINITION SHINGLES

	1 ⁴	2	3	4 ⁴	5
Most Popular Colors:					
Barkwood	•	•	•	•	•
Charcoal	•	•	•	•	•
Hickory	•	•	•	•	•
Pewter Gray	•		• ¹	•	
Shakewood	•	•	• ¹	•	•
Slate	•	•	• ¹	•	•
Weathered Wood	•	•	•	•	•
Regional Colors:					
Fox Hollow Gray	•			•	
Hunter Green	•			•	
Patriot Red	•			•	

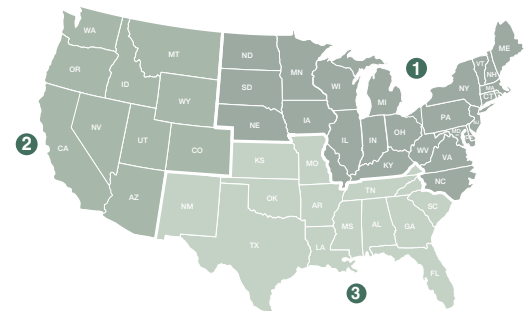
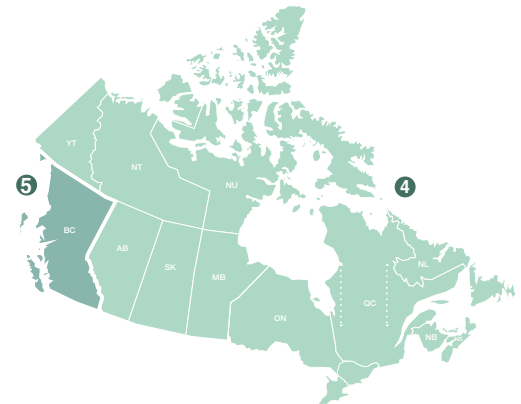

¹Limited availability.

²Rated by the Cool Roof Rating Council (CRRC) and can be used to comply with 2016 Title 24, Part 6, Cool Roof Requirements of the California Code of Regulations.

³Timberline HD® White is ENERGY STAR® certified (U.S. only). Energy cost savings are not guaranteed and the amount of savings may vary based on climate zone, utility rates, radiative properties of roofing products, insulation levels, HVAC equipment efficiency, and other factors.

⁴Timberline Ultra HD® Shingles / Timberline® UHD Shingles in these areas have the Dual Shadow Line feature. For complete product specifications, visit gaf.com.

Most Popular

High Definition® Shingle Colors

(See chart at left for availability)

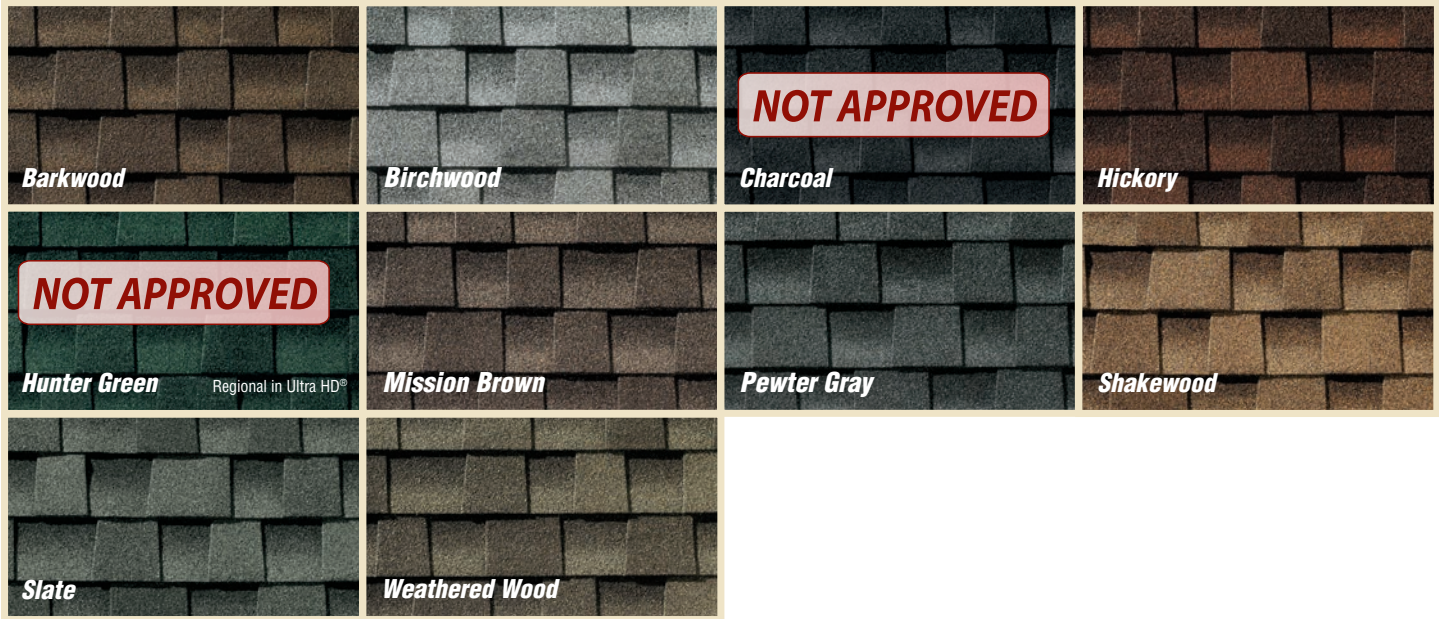

Regional

High Definition® Shingle Colors

(See chart at left for availability)



* StainGuard Plus™ Time-Release Technology is available only on Timberline Ultra HD® Shingles sold in packages bearing the StainGuard Plus™ logo. Products with StainGuard Plus™ Time-Release Technology are covered by a 25-year limited warranty against blue-green algae discoloration. See *GAF Shingle & Accessory Ltd. Warranty* for complete coverage and restrictions.

** StainGuard® algae protection is available only on shingles sold in packages bearing the StainGuard® logo. Products with StainGuard® algae protection are covered by a 10-year limited warranty against blue-green algae discoloration. See *GAF Shingle & Accessory Ltd. Warranty* for complete coverage and restrictions.

Note: It is difficult to reproduce the color clarity and actual color blends of these products. Before selecting your color, please ask to see several full-size shingles.

1, 2, 3 See footnotes on previous page





TIMBERLINE® American Harvest®

LIFETIME SHINGLES

(Only available in the U.S.)

Designed to complement your home's exterior color scheme, the American Harvest® Collection will give you that modern architectural style you want, at a price you can afford!

The Timberline® American Harvest® line has been enhanced for maximum appeal, adding greater dimensionality and beauty with higher contrast and on-trend colors.



TIMBERLINE® LIFETIME SHINGLES



*StainGuard® algae protection is available only on shingles sold in packages bearing the StainGuard® logo. Products with StainGuard® algae protection are covered by a 10-year limited warranty against blue-green algae discoloration. See *GAF Shingle & Accessory Ltd. Warranty* for complete coverage and restrictions.

Note: It is difficult to reproduce the color clarity and actual color blends of these products. Before selecting your color, please ask to see several full-size shingles.



Color Shown:
Golden Harvest



Saddlewood Ranch*

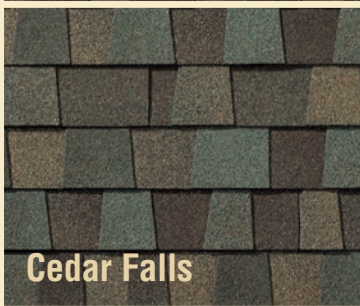

Cedar Falls



Nantucket Morning*



Appalachian Sky*



Golden Harvest



Midnight Blush**



Amber Wheat^{4,***}

TIMBERLINE® LIFETIME
SHINGLES — NORTH AMERICA'S
#1 — SELLING ROOF

Surprising Colors That Reflect The Beauty Of America's Heartland

- **Custom-Designed Color Palette...** Professionally designed color palette featuring subtle blends with contrasting colors that will add sophistication and charm to any home.
- **Extra-Dimensional...** Optimized construction and advanced color application techniques result in an extra-dimensional look.
- **Great Value...** Architecturally stylish, but practically priced — with a Lifetime Ltd. warranty.¹
- **Highest Roofing Fire Rating...** UL Class A, Listed to ANSI/UL 790.
- **High Performance...** Designed with Advanced Protection® Shingle Technology, which reduces the use of natural resources while providing excellent protection for your home (visit gaf.com/aps to learn more).
- **Stays In Place...** Dura Grip™ Adhesive seals each shingle tightly and reduces the risk of shingle blow-off. Shingles warranted to withstand winds up to 130 mph!²
- **Peace Of Mind...** Lifetime Ltd. transferable warranty with Smart Choice® Protection (non-prorated material and installation labor coverage) for the first ten years!¹
- **Perfect Finishing Touch...** Use Timbertex® Premium Ridge Cap Shingles with StainGuard® algae protection or TimberCrest™ Premium SBS-Modified Ridge Cap Shingles.³

¹ See GAF Shingle & Accessory Ltd. Warranty for complete coverage and restrictions. The word "Lifetime" refers to the length of coverage provided by the GAF Shingle & Accessory Ltd. Warranty and means as long as the original individual owner(s) of a single-family detached residence [or the second owner(s) in certain circumstances] owns the property where the shingles are installed. For owners/structures not meeting the above criteria, Lifetime coverage is not applicable.

² This wind speed coverage requires special installation; see GAF Shingle & Accessory Ltd. Warranty for details.

³ These products are not available in all areas. See www.gaf.com/ridgecapavailability for details.

⁴ Timberline® American Harvest® Amber Wheat is rated by the Cool Roof Rating Council (CRRCC).

* Available only in the North, Central, Southeast, and Southwest Areas of the U.S.

** Available only in the Northeast and Central Areas of the U.S.

*** Available only in the Southeast, Southwest, and West Areas of the U.S.

Where They Fit Within The Lifetime Roofing System

1. Lifetime Shingles

2. Leak Barrier
3. Starter Strip Shingles
4. Roof Deck Protection
5. Cobra® Attic Ventilation
6. Ridge Cap Shingles

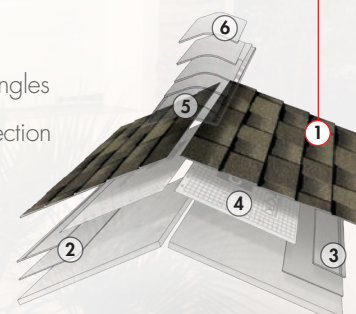



TIMBERLINE® Natural Shadow™

LIFETIME SHINGLES

(Only available in the U.S.)

Color Shown:
Barkwood

TIMBERLINE® LIFETIME SHINGLES



*StainGuard® algae protection is available only on shingles sold in packages bearing the StainGuard® logo. Products with StainGuard® algae protection are covered by a 10-year limited warranty against blue-green algae discoloration. See *GAF Shingle & Accessory Ltd. Warranty* for complete coverage and restrictions.

Note: It is difficult to reproduce the color clarity and actual color blends of these products. Before selecting your color, please ask to see several full-size shingles.



Barkwood*

Shakewood*

Slate*

Weathered Wood*

Charcoal*

Hickory*

Pewter Gray*

ENERGY STAR® CERTIFIED! (White Only)

Arctic White^{4,5,*}



TIMBERLINE® LIFETIME SHINGLES — NORTH AMERICA'S #1 — SELLING ROOF

Value & Performance In A Natural Wood-Shake Look

- **Attractive Appearance...** Features a classic shadow effect. Lends any home a subtle, even-toned look with the warmth of wood.
- **Great Value...** Architecturally stylish but practically priced.
- **High Performance...** Designed with Advanced Protection® Shingle Technology, which reduces the use of natural resources while providing excellent protection for your home (visit gaf.com/aps to learn more).
- **Highest Roofing Fire Rating...** UL Class A, Listed to ANSI/UL 790.
- **Stays In Place...** Dura Grip™ Adhesive seals each shingle tightly and reduces the risk of shingle blow-off. Shingles are warranted to withstand winds up to 130 mph.¹
- **Peace Of Mind...** Lifetime Ltd. transferable warranty with Smart Choice® Protection (non-prorated material and installation labor coverage) for the first ten years.²
- **Perfect Finishing Touch...** Use TimberTex® Premium Ridge Cap Shingles or TimberCrest™ Premium SBS/Modified Ridge Cap Shingles.³

¹ This wind speed coverage requires special installation; see *GAF Shingle & Accessory Ltd. Warranty* for details.

² See *GAF Shingle & Accessory Ltd. Warranty* for complete coverage and restrictions. The word "Lifetime" refers to the length of coverage provided by the *GAF Shingle & Accessory Ltd. Warranty* and means as long as the original individual owner(s) of a single-family detached residence (or the second owner(s) in certain circumstances) owns the property where the shingles are installed. For owners/structures not meeting the above criteria, Lifetime coverage is not applicable.

³ These products are not available in all areas. See www.gaf.com/ridgecapavailability for details.

⁴ Energy cost savings are not guaranteed and the amount of savings may vary based on climate zone, utility rates, radiative properties of roofing products, insulation levels, HVAC equipment efficiency, and other factors.

⁵ Timberline® Natural Shadow® Arctic White can be used to comply with 2016 Title 24, Part 6, Cool Roof Requirements of the California Code of Regulations; is rated by the Cool Roof Rating Council (CRRC); and meets Green Building Standards Code of Los Angeles County for residential buildings.

*** Notes on Color Availability:**

- Arctic White only available in the Shafter Service Area.
- Pewter Gray only available in the Baltimore/Myerstown, Michigan City, Minneapolis, and Tuscaloosa Service Areas.
- Timberline® Natural Shadow® Shingles are not available in the Tampa Service Area.

Where They Fit Within The Lifetime Roofing System

1. Lifetime Shingles

2. Leak Barrier
3. Starter Strip Shingles
4. Roof Deck Protection
5. Cobra® Attic Ventilation
6. Ridge Cap Shingles

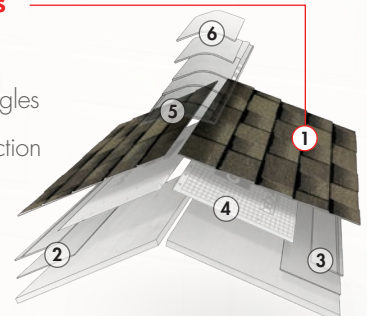



TIMBERLINE®
COOLSERIES®
 ENERGY-SAVING SHINGLES
 (Only available in the U.S.)

TIMBERLINE® LIFETIME SHINGLES



*StainGuard® algae protection is available only on shingles sold in packages bearing the StainGuard® logo. Products with StainGuard® algae protection are covered by a 10-year limited warranty against blue-green algae discoloration. See *GAF Shingle & Accessory Ltd. Warranty* for complete coverage and restrictions.

Note: It is difficult to reproduce the color clarity and actual color blends of these products. Before selecting your color, please ask to see several full-size shingles.

The revolutionary Timberline® Cool Series® Shingles reflect sunlight to help reduce unwanted attic heat build-up and may help save on air-conditioning costs.¹ They can be used to comply with L.A. County roofing product requirements, are rated by the Cool Roof Rating Council (CRRC), and are ENERGY STAR® certified (U.S. only).¹



Color Shown:
Cool Barkwood

Cool Barkwood

Cool Antique Slate

Cool Weathered Wood



*Can be used to comply with 2015 Title 24, Part 6, Cool Roof Requirements of the California Code of Regulations

TIMBERLINE® LIFETIME SHINGLES — NORTH AMERICA'S #1 — SELLING ROOF

Revolutionary Cool Roofing

- **Helps Reduce Cooling Costs...** Cool roofs may help you save on cooling costs.¹
- **Rebates...** Some utility companies may provide incentives for using cool shingles.

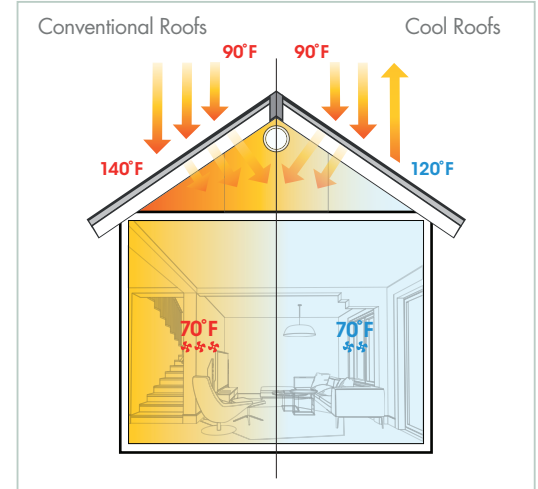

Thanks to the reflective nature of Timberline® Cool Series® Shingles, part of the heat radiating from the sun gets reflected, helping to reduce the heat in the attic and heat going into the house. It may translate into savings on air-conditioning bills.¹

TIMBERLINE® COOL SERIES® REFLECTANCE & EMITTANCE DATA

Color	Solar Reflectance	Thermal Emittance	Solar Reflectance Index (SRI)
Cool Antique Slate	0.28 (Initial) 0.26 (Aged)	0.92 (Initial) 0.91 (Aged)	30 (Initial) 27 (Aged)
Cool Barkwood	0.27 (Initial) 0.26 (Aged)	0.90 (Initial) 0.92 (Aged)	28 (Initial) 28 (Aged)
Cool Weathered Wood	0.28 (Initial) 0.27 (Aged)	0.92 (Initial) 0.90 (Aged)	30 (Initial) 28 (Aged)

¹ Energy cost savings are not guaranteed and the amount of savings may vary based on climate zone, utility rates, radiative properties of roofing products, insulation levels, HVAC equipment efficiency, and other factors.

Where They Fit Within The Lifetime Roofing System

1. Lifetime Shingles

2. Leak Barrier
3. Starter Strip Shingles
4. Roof Deck Protection
5. Cobra® Attic Ventilation
6. Ridge Cap Shingles

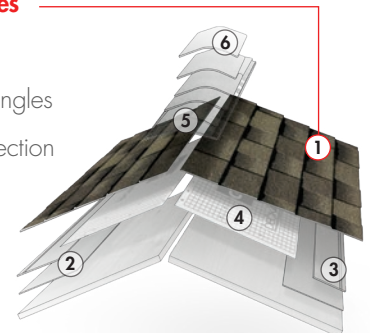



Glenwood[®]

LIFETIME *Designer* SHINGLES

The Most Authentic Wood Shake-Look Shingles You Can Buy

LIFETIME DESIGNER SHINGLES — ULTRA-PREMIUM COLLECTION



*StainGuard[®] algae protection is available only on shingles sold in packages bearing the StainGuard[®] logo. Products with StainGuard[®] algae protection are covered by a 10-year limited warranty against blue-green algae discoloration. See *GAF Shingle & Accessory Ltd. Warranty* for complete coverage and restrictions.

Note: It is difficult to reproduce the color clarity and actual color blends of these products. Before selecting your color, please ask to see several full-size shingles.



Color Shown:
Golden Prairie**

****Glenwood® Golden Prairie is rated by the Cool Roof Rating Council (CRRC) and can be used to comply with 2016 Title 24, Part 6, Cool Roof Requirements of the California Code of Regulations.**



Golden Prairie**

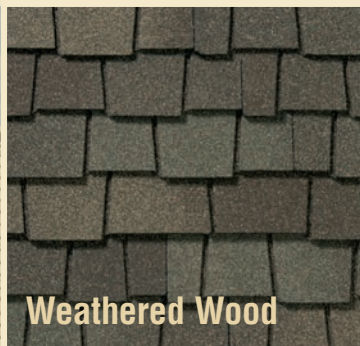

Weathered Wood

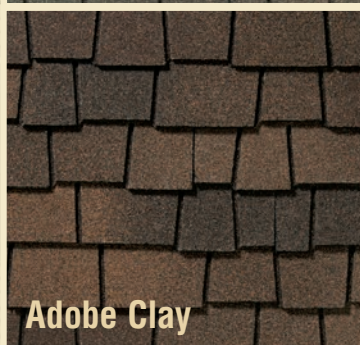

Adobe Clay

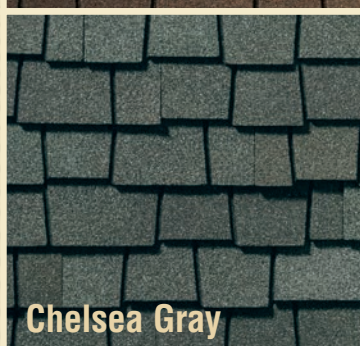

Chelsea Gray



Autumn Harvest

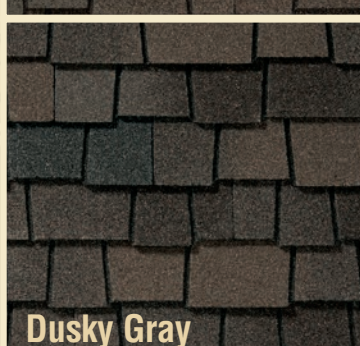

Dusky Gray



Grand Canyon®

LIFETIME *Designer* SHINGLES

The Ultimate Choice For A Rugged Wood-Shake Look

LIFETIME DESIGNER SHINGLES — ULTRA-PREMIUM COLLECTION



*StainGuard® algae protection is available only on shingles sold in packages bearing the StainGuard® logo. Products with StainGuard® algae protection are covered by a 10-year limited warranty against blue-green algae discoloration. See *GAF Shingle & Accessory Ltd. Warranty* for complete coverage and restrictions.

This product is not available in all areas. See gaf.com for availability and details.

Note: It is difficult to reproduce the color clarity and actual color blends of these products. Before selecting your color, please ask to see several full-size shingles.



Color Shown:
Storm Cloud Gray

GAF

CAMELOT® II

LIFETIME Designer SHINGLES

A Classic, Artisan-Crafted Look
At A Surprisingly Affordable Price



*StainGuard® algae protection is available only on shingles sold in packages bearing the StainGuard® logo. Products with StainGuard® algae protection are covered by a 10-year limited warranty against blue-green algae discoloration. See *GAF Shingle & Accessory Ltd. Warranty* for complete coverage and restrictions.

**Uses premium color shingle granules in an exclusively formulated color blend.

Note: It is difficult to reproduce the color clarity and actual color blends of these products. Before selecting your color, please ask to see several full-size shingles.

GAF

Woodland®

LIFETIME Designer SHINGLES

The Stylish Look Of Hand-Cut
European Shingles...At An
Incredibly Affordable Price



*StainGuard® algae protection is available only on shingles sold in packages bearing the StainGuard® logo. Products with StainGuard® algae protection are covered by a 10-year limited warranty against blue-green algae discoloration. See *GAF Shingle & Accessory Ltd. Warranty* for complete coverage and restrictions.

**Uses premium color shingle granules in an exclusively formulated color blend.

Note: It is difficult to reproduce the color clarity and actual color blends of these products. Before selecting your color, please ask to see several full-size shingles.

LIFETIME DESIGNER SHINGLES — VALUE COLLECTION



Color Shown:
Royal Slate

PREMIUM COLOR BLEND**		NOT APPROVED		PREMIUM COLOR BLEND**	
Weathered Timber	Antique Slate	Charcoal	Barkwood	Royal Slate	

** See footnote on previous page



Color Shown:
Tuscan Sunset

Tuscan Sunset	Cedarwood Abbey	Castlewood Gray	Woodberry Brown	PREMIUM COLOR BLEND**	
				Mountain Sage	

** See footnote on previous page



GRAND SEQUOIA®

LIFETIME Designer SHINGLES

Great Value For A Rugged Wood-Shake Look



*StainGuard® algae protection is available only on shingles sold in packages bearing the StainGuard® logo. Products with StainGuard® algae protection are covered by a 10-year limited warranty against blue-green algae discoloration. See *GAF Shingle & Accessory Ltd. Warranty* for complete coverage and restrictions.

**Uses premium color shingle granules in an exclusively formulated color blend.



SLATELINE®

LIFETIME Designer SHINGLES

The Look Of Slate...
At A Fraction Of The Cost



*StainGuard® algae protection is available only on shingles sold in packages bearing the StainGuard® logo. Products with StainGuard® algae protection are covered by a 10-year limited warranty against blue-green algae discoloration. See *GAF Shingle & Accessory Ltd. Warranty* for complete coverage and restrictions.

**Uses premium color shingle granules in an exclusively formulated color blend.

This product is not available in all areas. See gaf.com for availability and details.

Note: It is difficult to reproduce the color clarity and actual color blends of these products. Before selecting your color, please ask to see several full-size shingles.

LIFETIME DESIGNER SHINGLES — VALUE COLLECTION



Color Shown:
Cedar

<p>Weathered Wood (Only available in the Southwest & West Areas)</p>	<p>Autumn Brown</p>
<p>Slate (Only available in the Northeast, Southeast, and Central Areas)</p>	<p>Weathered Timber (Only available in the Northeast, Southeast and Central Areas)</p>

<p>Cedar</p>	<p>Charcoal</p>	<p>Mesa Brown</p>
---------------------	------------------------	--------------------------

NOT APPROVED

PREMIUM COLOR BLEND **

** See footnote on previous page



Color Shown:
Antique Slate

<p>PREMIUM COLOR BLEND **</p>			
<p>Royal Slate</p>	<p>Antique Slate (less contrast than English Gray)</p>	<p>English Gray (more contrast than Antique Slate)</p>	<p>Weathered Slate</p>

** See footnote on previous page

Beauty And Performance Meet Affordability

- **Proven Quality...** Over 10 billion Royal Sovereign® Shingles have been installed in North America — enough to circle the Earth more than 200 times if they were laid end to end!
- **Advanced Protection® Shingle Technology...** Reduces the use of precious natural resources while providing excellent protection for your home (visit gaf.com/aps to learn more).
- **Looks Great...** Color Lock™ Ceramic Firing (granules) helps maintain the true shingle color.
- **StainGuard® Algae Protection...** Helps ensure the beauty of your roof against unsightly blue-green algae.*
- **Stays In Place...** Passes the industry's two toughest wind tests: ASTM's D3161 Class F, 110 mph and D7158 Class H, 150 mph wind tests (under controlled laboratory conditions).**
- **Excellent Performance...** Micro Weave™ Core offers a strong foundation that helps resist cracking and splitting.
- **Highest Roofing Fire Rating...** UL Class A, Listed to ANSI/UL 790.
- **Great For Resale...** Long-lasting beauty may increase your home's resale value.
- **Peace Of Mind...** 25-year ltd. transferable warranty with Smart Choice® Protection (non-prorated material and installation labor coverage) for the first five years.***



Color Shown:
Autumn Brown

Most Popular Colors



Regional Colors



NOT APPROVED

NOT APPROVED

NOT APPROVED



*StainGuard® algae protection is available only on shingles sold in packages bearing the StainGuard® logo. Products with StainGuard® algae protection are covered by a 10-year limited warranty against blue-green algae discoloration. See *GAF Shingle & Accessory Ltd. Warranty* for complete coverage and restrictions.

**Royal Sovereign® Shingles are warranted to withstand wind speeds up to 60 mph. See *GAF Shingle & Accessory Ltd. Warranty* for complete coverage and restrictions.

***See *GAF Shingle & Accessory Ltd. Warranty* for complete coverage and restrictions.

(Only available in the U.S. For information about Marquis Weather Max® Three-tab Shingles, which are available in Canada, visit gaf.ca.)

¹ ENERGY STAR® certified (U.S. only). Energy cost savings are not guaranteed and the amount of savings may vary based on climate zone, utility rates, radiative properties of roofing products, insulation levels, HVAC equipment efficiency, and other factors.

² Royal Sovereign® White can be used to comply with 2016 Title 24, Part 6, Cool Roof Requirements of the California Code of Regulations; is rated by the Cool Roof Rating Council (CRRC); and meets Green Building Standards Code of Los Angeles County for residential buildings.